

# Agilent GSM/EDGE Base Station Test with the E4406A VSA and ESG-D Series RF Signal Generators

Product Overview

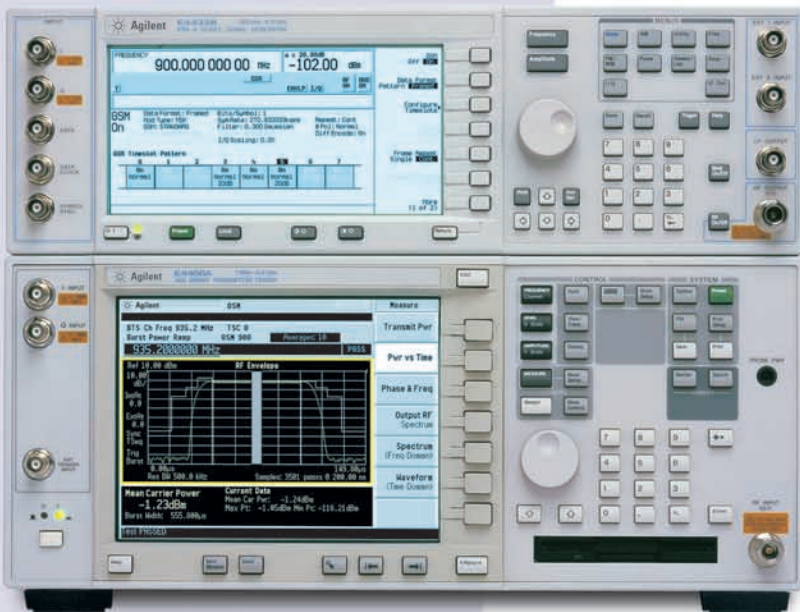

# The flexible GSM/EDGE base station test solution with a 3G future...

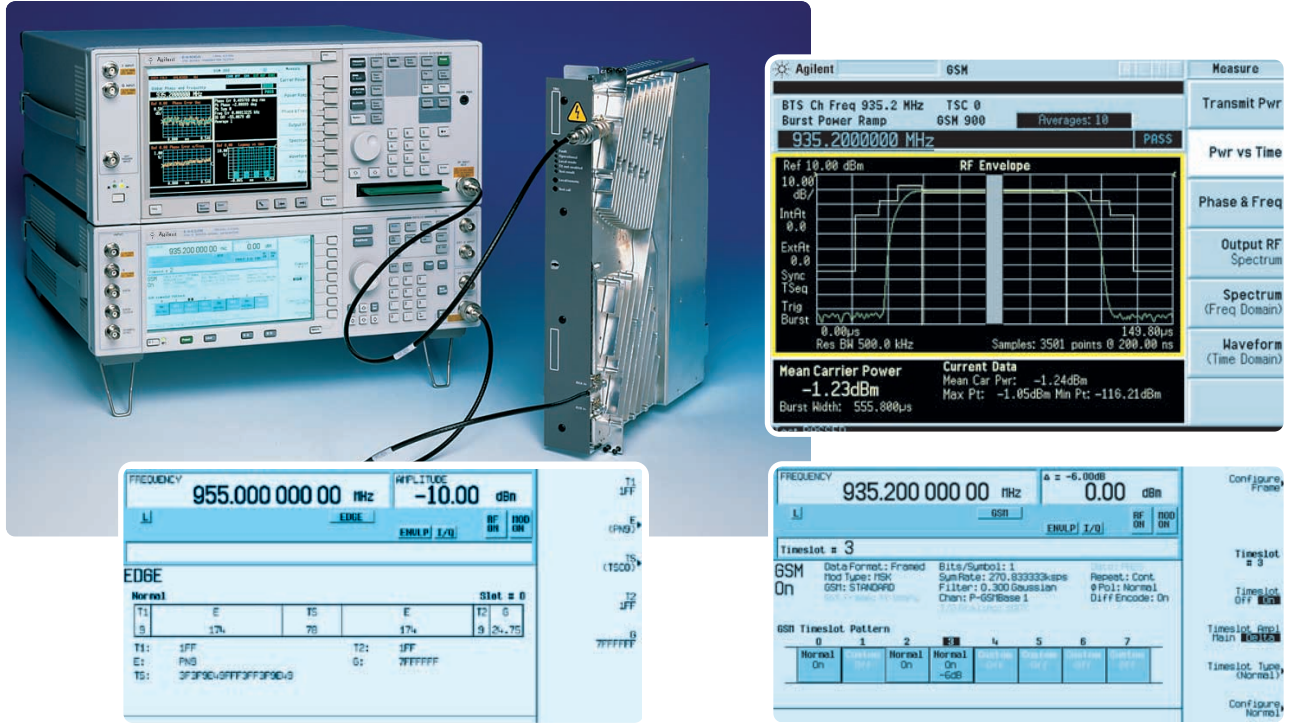

## Designed for manufacturing

As the second generation of wireless telecommunications reaches maturity, base station manufacturers are testing an increasing variety of products. Flexible test equipment is needed to accommodate products designed with different specifications and levels of integration.

Also, manufacturers are facing increasing pressure to support emerging standards like W-CDMA in addition to GSM and EDGE.

The Agilent E4406A VSA with an Agilent ESG-D series RF signal generator is an ideal combination for GSM/EDGE base station test, providing both flexibility and support for new standards. In addition, both instruments are optimized for performance and ease of use.

## A full suite of measurements

Perform all of the transmit and receive tests required for your GSM/EDGE base station:

- **Transmitter measurements**
  - Mean transmitter carrier power
  - Power versus time
  - Output RF Spectrum (ORFS)
  - Phase and frequency error
- **EVM**
- **Receiver measurements**
  - RBER
  - FER
  - Sensitivity search
  - BER/BLER

## The performance you need

Both the E4406A VSA and the ESG-D series deliver superior performance for your measurements:

- Fast measurements for increased throughput
- Superior power level accuracy for reduced test margins
- High dynamic range for stringent ORFS specifications

## The flexibility of separate platforms

Since the transmitter and receiver test platforms are separate, full-featured instruments, they can be easily configured to meet your needs. For example, additional ESG-D series generators can provide interfering signals for blocking, adjacent channel and co-channel interference tests.

## ...based on upgradable platforms that will evolve with your measurement needs

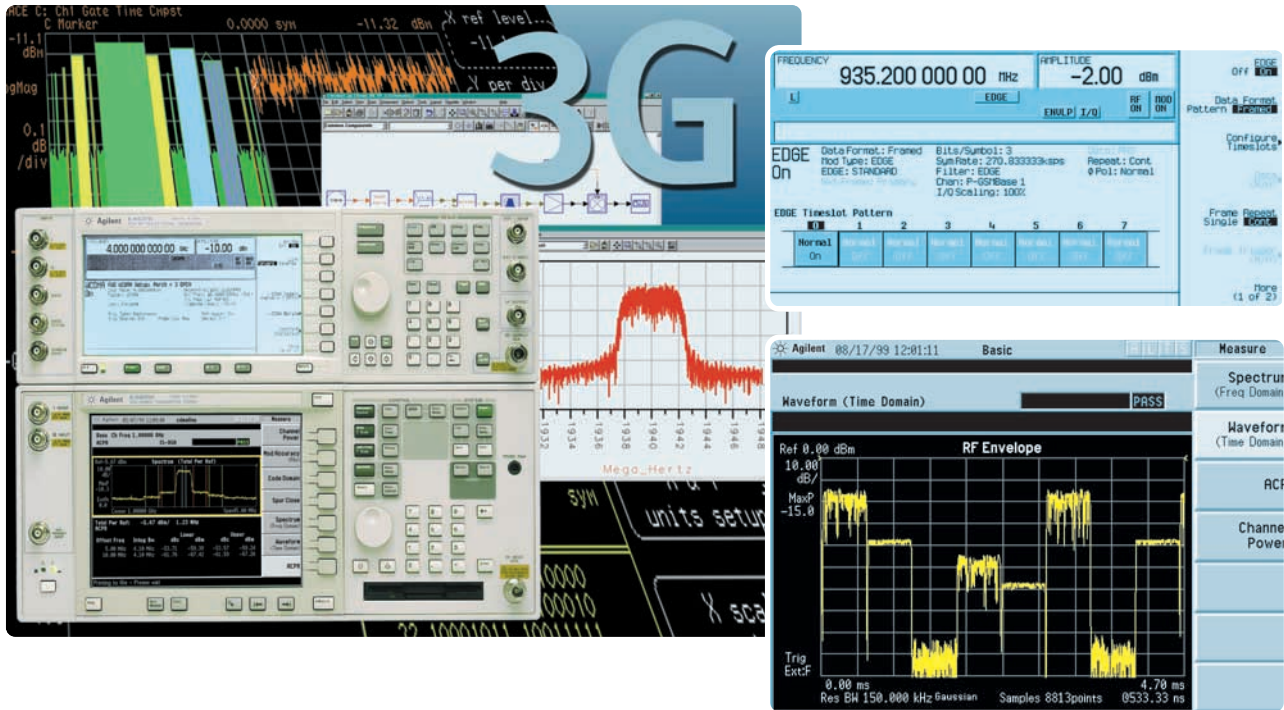

### Multiple formats for tomorrow's manufacturing environment

If you manufacture base stations for multiple wireless systems, or plan to move to new formats in the future, you will enjoy the security of owning test equipment that supports all major standards<sup>1</sup> for today and tomorrow:

- GSM, NADC, PDC, and IS-95A
- W-CDMA, cdma2000, and EDGE

### Keeping pace with emerging standards

Participation in standards committees assures our ability to keep up-to-date with the latest developments in 3G standards.

The record of the ESG-D series demonstrates this. Built upon a similar platform, the E4406A VSA provides the same security. Both instruments offer:

- High performance for the rigorous demands of 3G systems
- Firmware upgrades for easy and inexpensive updates

### Connected solutions for design through manufacturing

The base stations of tomorrow are in development today. The E4406A VSA and the ESG-D series are part of a family of connected solutions that includes the Agilent 89400 series vector signal analyzers and design tools like the Agilent Advanced Design System. These solutions provide continuity from design through manufacturing test.

The E4406A VSA and the ESG-D series are flexible platforms that can be used in multiple phases of the product lifecycle, including design verification and type approval. Using the combination in R&D expedites integration into manufacturing.

1. Loopback bit error rate measurement is supported for GSM and EDGE only.

# Transmitter testing at the speed of the wireless revolution...

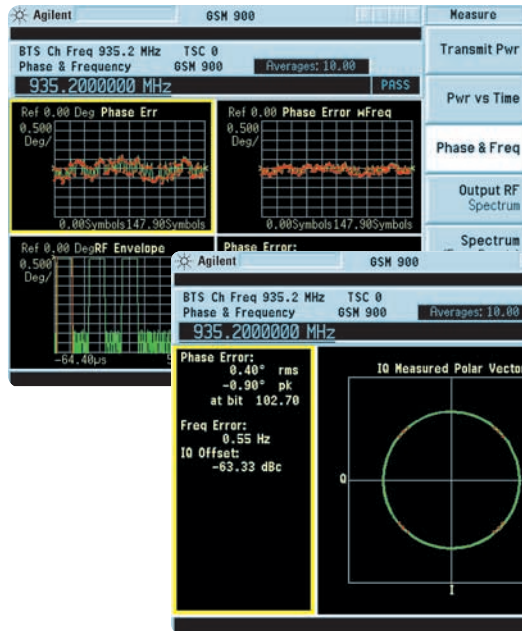

The ability to see data in multiple views eases analysis of results. For example, the phase and frequency error measurement allows you to view the IQ constellation or the phase and frequency error versus time.

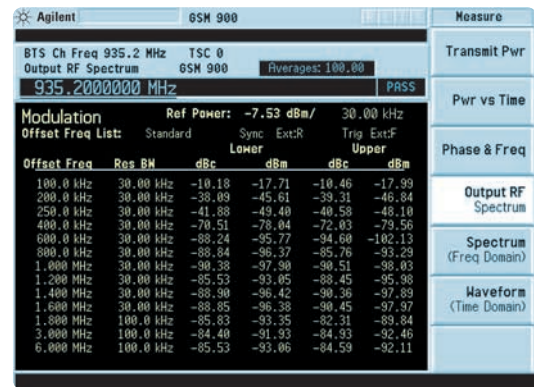

Stringent base station ORFS specifications, even at offsets of 6 MHz or greater from the carrier, are easily met by the transmitter tester's high dynamic range.

## A complete set of transmitter measurements

The E4406A VSA's GSM/EDGE measurement personality lets you quickly and efficiently perform GSM/EDGE measurements on GSM900, DCS1800 and PCS1900 transmitters. Key measurements are accessible at the touch of a button:

- Mean transmitter carrier power
- Power versus time
- Output RF Spectrum (ORFS) due to modulation and switching transients
- Phase and frequency error
- Spectrum measurements (frequency domain)
- Waveform measurements (time domain)
- EVM (error vector magnitude)

## The performance you demand

The E4406A VSA was designed with the manufacturer's needs in mind. Superior measurement speed improves throughput and excellent accuracy tightens your measurement tolerances.

- 760 milliseconds for GSM phase and frequency error measurements
- I/O interfaces optimized for fast data transfer
- ±0.20 dB amplitude linearity over a 76 dB range



## ...and high-performance receiver test

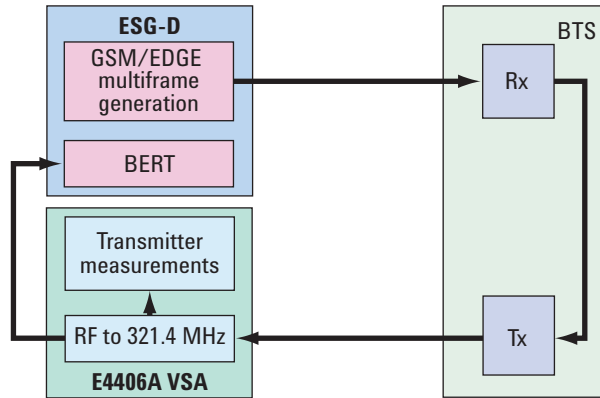
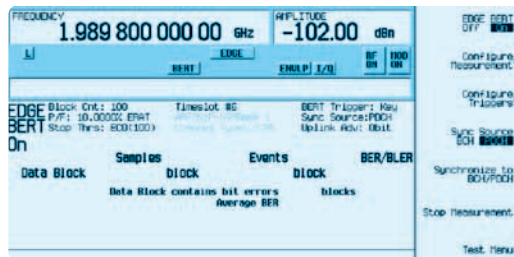
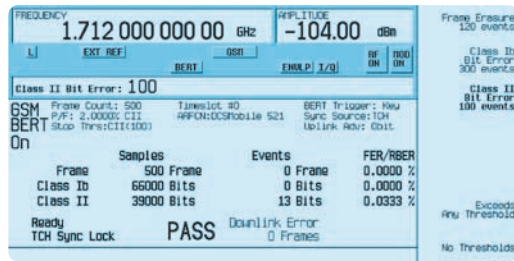

### Loopback BER test provides device-independent sensitivity tests

With loopback Bit Error Rate (BER), the interface between the test equipment and the BTS under test is the air interface defined by ETSI standards. GSM/EDGE base stations with a loopback test mode can be tested interchangeably, eliminating the need for custom interface software.

Using the E4406A VSA as a down-converter, the ESG-D series signal generator provides a loopback BER solution with the measurements you require:

- Frame Erasure Rate (FER)
- Residual Bit Error Rate (RBER) class Ib
- RBER class II
- High-speed sensitivity search
- Fully coded adjacent time slots
- Selected transmitter measurements made simultaneously by the E4406A VSA
- BER/BLER

### A wide variety of signal generation features

A full-featured ESG-D series signal generator is a complete and flexible GSM/EDGE source offering the features you need:

- A fast-switching full-range attenuator provides ETSI-compliant alternate time slot power level control (up to 130 dB) for receiver sensitivity testing
- Fully coded, ETSI-compliant time slots simulate real-world GSM and EDGE/EGPRS signals.

### A hardware platform that reduces your risk

The ESG-D series provides **superior performance and reliability**. Reduced test margins and test equipment that stays in the rack, ease test development and minimize downtime.

- Superior power level accuracy for reduced test margins
- Reliable electronic attenuator
- Excellent modulation accuracy (0.8° rms global phase error for GMSK) with internal I/Q calibration that remains valid for up to 30 days

# The E4406A VSA and ESG-D series combination—a total solution

## Striving to meet all your measurement needs

The performance of the E4406A VSA and ESG-D series is only one part of what you get from Agilent Technologies. Agilent provides complete solutions that go beyond our customers' expectations. We offer the depth and breadth of enhancements, software, services, connectivity, accessibility and support that you need to reach your measurement objectives.

### PC connectivity

- Agilent EEsof advanced design system driver instrument link
- GPIB or RS-232 interfaces
- VXI plug&play drivers
- Floppy disk drive (Agilent VSA)
- 10 baseT LAN port (VSA)

### Engineering services

- Rentals, leasing, and financing
- Application engineering services
- Custom product modifications
- Custom downloadable programs

### Continuing service and support

- Standard three-year global warranty
- Downloadable waveforms for the internal dual arbitrary waveform generator
- Worldwide call center and service center support network
- Firmware upgrades downloadable from the Web

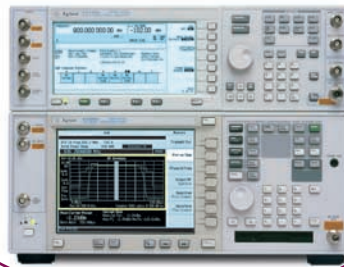

### Product and peripheral interfaces

- Agilent 83300 remote interface (ESG-D series)
- Parallel printer port (VSA)
- SCSI interface for ZIP drive upgrades (VSA)
- VGA monitor output (VSA)

### Software

- Programming examples on CD-ROM
- SCPI (Standard Commands for Programmable Instruments)
- PC-based performance verification and adjustment software

### Training and application information

- Manuals on CD-ROM and the Web
- Factory service training
- On-site user training
- Application and product notes
- Web-based answers to frequently asked questions
- Literature and data sheets on the Web

## Additional information

For the latest information on the E4406A VSA and ESG-D series combination for base station test, see our Web site at:

[www.agilent.com/find/wireless](http://www.agilent.com/find/wireless)

### Literature

Please visit the Agilent site for online access to literature including application and product notes, or contact your Agilent sales office.

- *Understanding GSM Transmitter and Receiver Measurements for Base Transceiver Stations and Mobile Stations*, Application Note 1312, literature number 5968-2320E.

- *ESG Family of RF Signal Generators*, Technical Specifications, literature number 5965-3096E.

- *VSA-Series Transmitter Tester*, Technical Specifications, literature number 5968-3030E.

### Free firmware upgrades

See the E4406A VSA and ESG family Web sites for free firmware upgrades:

[www.agilent.com/find/esg](http://www.agilent.com/find/esg)

[www.agilent.com/find/vsa](http://www.agilent.com/find/vsa)

## Ordering information

The ESG-D series signal generator and the E4406A VSA are available in two convenient ordering bundles, preconfigured for GSM basestation test and for GSM/EDGE basestation test.

#### GSM BTS test: E4433Z Option 301

E4433B ESG (4 GHz)

#UN8 (real-time I/Q baseband generator)

#300 (includes baseband BER tester)

#UNA (alternate time slot level control)

#1CP (rackmount and handle kit)

#1E5 (high-stability timebase)

E4406A VSA

#BAH (GSM measurement personality)

#300 (321.4 MHz output)

#1CP (rackmount and handle kit)

#### GSM/EDGE BTS test: E4433Z

##### Option 302

E4433B ESG (4 GHz)

#UN8 (real-time I/Q baseband generator)

#300 (includes baseband BER tester)

#202 (EDGE personality)

#UNA (alternate time slot level control)

#1CP (rackmount and handle kit)

#1E5 (high-stability timebase)

E4406A VSA

#202 (GSM & EDGE measurement personality)

#300 (321.4 MHz output)

#1CP (rackmount and handle kit)

For information about additional options and upgrades, please contact your local Agilent sales office.

### **Agilent Technologies' Test and Measurement Support, Services, and Assistance**

Agilent Technologies aims to maximize the value you receive, while minimizing your risk and problems. We strive to ensure that you get the test and measurement capabilities you paid for and obtain the support you need. Our extensive support resources and services can help you choose the right Agilent products for your applications and apply them successfully. Every instrument and system we sell has a global warranty. Support is available for at least five years beyond the production life of the product. Two concepts underlie Agilent's overall support policy: "Our Promise" and "Your Advantage."

#### **Our Promise**

Our Promise means your Agilent test and measurement equipment will meet its advertised performance and functionality. When you are choosing new equipment, we will help you with product information, including realistic performance specifications and practical recommendations from experienced test engineers. When you use Agilent equipment, we can verify that it works properly, help with product operation, and provide basic measurement assistance for the use of specified capabilities, at no extra cost upon request. Many self-help tools are available.

#### **Your Advantage**

Your Advantage means that Agilent offers a wide range of additional expert test and measurement services, which you can purchase according to your unique technical and business needs. Solve problems efficiently and gain a competitive edge by contracting with us for calibration, extra-cost upgrades, out-of-warranty repairs, and on-site education and training, as well as design, system integration, project management, and other professional engineering services. Experienced Agilent engineers and technicians worldwide can help you maximize your productivity, optimize the return on investment of your Agilent instruments and systems, and obtain dependable measurement accuracy for the life of those products.

**By internet, phone, or fax, get assistance with all your test and measurement needs.**

**Online assistance:**

**[www.agilent.com/find/assist](http://www.agilent.com/find/assist)**

**Phone or Fax:**

**United States:**

(tel) 1 800 452 4844

**Canada:**

(tel) 1 877 894 4414

(fax) (905) 282-6495

**Europe:**

(tel) (31 20) 547 2323

(fax) (31 20) 547 2390

**Japan:**

(tel) (81) 426 56 7832

(fax) (81) 426 56 7840

**Latin America:**

(tel) (305) 269 7500

(fax) (305) 269 7599

**Australia:**

(tel) 1 800 629 485

(fax) (61 3) 9210 5947

**New Zealand:**

(tel) 0 800 738 378

(fax) 64 4 495 8950

**Asia Pacific:**

(tel) (852) 3197 7777

(fax) (852) 2506 9284

**Product specifications and descriptions in this document subject to change without notice.**

**Copyright © 2000, 2001**

**Agilent Technologies**

**Printed in USA, April 17, 2001**

**5968-8333E**



**Agilent Technologies**